

**HLL LIFECARE LTD,
CENTRAL ENGINEERING DIVISION
PEROORKADA FACTORY,
THIRUVANANTHAPURAM – 695 005,
KERALA, INDIA.
PHN: ++91 471 2437270
FAX: ++91 471 2432647**

TENDER DOCUMENT

SUPPLY OF BRUSHES

AT

HLL KANAGALA FACTORY

**IFB No. : HLL/CED/CON-AUG /SUPPLY/ BRUSHES/BTADL CDM/KFB/2014
DATE : 19.02.2014**

HLL LIFECARE LIMITED
(A Government of India Enterprise)
Central Engineering Division, Peroorkada. P.O,
Thiruvananthapuram – 695005,
Kerala, India
Phn: 0471- 2433374,2437270, 2435090
Fax No. (0471) 2432647

INVITATION FOR BIDS (IFB)

IFB No. : HLL/CED/CON-AUG /SUPPLY/ BRUSHES/BTADL CDM/KFB/2014
DATE : 19.02.2014

HLL Lifecare Limited (HLL) invites sealed and super scribed bids from competent and experienced eligible Suppliers/Contractors for the supply of following item in connection with the Augmentation of condom production at our factory in Kanagala, Karnataka.

Sl. No	Brief Description of Item/Work	Quantity
1	Supply of Brushes as per drawing , specifications and schedule at HLL, Kanagala Factory, Karnataka	As per schedule of items

I. INSTRUCTION TO BIDDERS:

1. A complete set of bid documents can be had from the Office of the Associate Vice President (CED), Central Engineering Division, HLL Lifecare Limited, Peroorkada Factory, Thiruvananthapuram – 695 005, Kerala, India during office hours on any working day on submission of written application.

The Tender Documents can also be downloaded from our Website www.lifecarehll.com and the Central Public Procurement Portal of Government of India www.eprocure.gov.in from the date of issue of tender document. Tender forms shall be filled in ink or typed. No tender filled in pencil shall be considered. The tenderer shall sign and seal the form at each page and at the end, in token of acceptance of all the terms and conditions of the tender. Any subsequent changes/amendments will be published only in our website & CPP portal.

2. The scheduled date for issue, receipt and opening of bids is as follows.

- a) Date of issue of tender document - 19.02.2014
- b) Last date and time for receipt of bids - 26.02.2014 up to 15.00 Hrs.
- c) Date and time of opening of bids - 26.02.2014, 15.30 Hrs.

d) Address for communication, receipt and place of opening of bids:

Associate Vice President (CED)
Central Engineering Division,
HLL Lifecare Limited (A Government of India Enterprise),
PB No 2, Peroorkada, Thiruvananthapuram – 695005,
Kerala State, India
Ph: (++91 471) 2433374,2437270 –501,502
Tele Fax: (++ 91 471) 2432647
E-mail: srnair@lifecarehll.com, rajeevrv@lifecarehll.com

3. All the bidders are requested to attend the pre-bid meeting is scheduled on 14-01-2013, 2.30PM at AVP(CED)'s office

4. The Bid must include the following information;

- a. Enquiry No.
- b. EMD
- c. Promised Delivery Schedule for each item.
- d. Acceptance Form (Schedule III)
- e. Price Schedule in Format For Quoting (Schedule IV)
- f. All other documents/certificate/information as specified in the bid document.

5. Each bid must be accompanied by E.M.D. The EMD shall be in the form of Demand Draft from a nationalized bank drawn in favour of HLL LIFECARE LTD, Thiruvananthapuram payable at Thiruvananthapuram. E.M.D. of the unsuccessful bidders will be released after evaluating tenders, keeping only the earnest money of the first three lowest bidders. The earnest money deposit of the remaining two unsuccessful bidders will be released after the acceptance of the notification of award by the successful bidder. The EMD may be forfeited, if a Bidder withdraws his bid during the period of bid validity specified by the Bidder on the Bid Document.

6. SSI units interested in availing exemption from payment of EMD should submit a valid copy of their registration certificate issued by the concerned DIC or NSIC.

7. In addition to the invitation for bids, the bidding documents include the following schedules.

Schedule I - Instruction to the Bidders
Schedule II - Conditions of Contract
Schedule III - Acceptance Form
Schedule IV - Format for quoting

8. The completed and sealed bid documents should be submitted to Associate Vice President (CED), in the above address. The outer cover should bear the Enquiry No, closing date and General description of item tendered, and the words "DO NOT OPEN BEFORE" 15.30 Hrs (IST) on ----- (Indicate the Closing Date).

9. Bids will be opened in the presence of bidders' representative(s) who choose to attend on the specified date and time, at the office of HLL at the address given in Clause 2 (d) above.

10. In the event of the date specified for bid receipt and opening being declared as a closed holiday for purchaser's office, the due date for submission of bids and opening of bids will be the following working day at the appointed times.

11. The purchaser may, at its discretion, extend this deadline for submission of bids by amending the Bid Documents or any other reasons, in which case all rights and obligations of the Purchaser and Bidders previously subject to the deadline will thereafter be subject to the deadline as extended.

12. Purchaser will not be held responsible for the postal delay, if any, in the delivery of the bidding document or the non-receipt of the same. Bids sent by Telex/Fax/Telegraph will not be accepted.

13 HLL reserves the right to club or split the items of works, change the qualifying criteria at their discretion and to reject or cancel the Invitation for bids without assigning any reason thereof.

ASSOCIATE VICE PRESIDENT (CED)

SCHEDULE II

CONDITIONS OF CONTRACT

1) PRICE

The price quoted should be inclusive of Basic Price, all applicable taxes and duties including VAT, Entry tax, Octroi & other levies, P&F charges, loading and unloading charges, insurance, etc. The Supplier should pay entry taxes, as applicable and should be included in the offer.

The Format for Quoting (Schedule IV) shall be suitably filled as applicable. The quoted rate shall be valid for a period of 31st March 2014. No price escalation and no change in terms and conditions will be allowed on any ground till the order is completely executed.

2) TAXES/DUTIES/LEVIES

The supplier shall be entirely responsible for all taxes including entry tax, duties, license fees, etc. incurred until successful completion of contract. All central, state, municipal taxes, duties and levies payable shall be shown by the bidder separately in the Bid. The Purchaser will issue necessary 'C' Form, if required.

3) COMPLETION TIME

- a. The item should be delivered within 15 days from the date of issuing the Letter of Intent or Supply Order.
- b. The quantity mentioned herein are approximate requirement with staggered delivery.
- c. In case less or more quantity is required the suppliers should be prepared to effect supply at short notice on the same terms and conditions.

4) GUARANTEE PERIOD

The Guarantee against any possible manufacturing defects shall be given for a period of 18 months from the date of supply and inspection of the item at HLL site or 12 months from the date of supply, whichever is earlier.

5) DELIVERY ADDRESS

Senior Manager (CP)
HLL Lifecare Limited (A Government of India Enterprise),
Kanagala, Dist , Belgaum – 591225,
Karnataka State, India
Ph: (++91 833) 279244,279207
Tele Fax: (++ 91 833) 279245
e-mail:krknair@lifecarehll.com

6) ADDRESS FOR CORRESPONDENCE

Associate Vice President (CED)
Central Engineering Division,
HLL Lifecare Limited (A Government of India Enterprise),
PB No 2, Peroorkada, Thiruvananthapuram – 695005,
Kerala State, India
Ph: (++91 471) 2433374,2437270 –501,502
Tele Fax: (++ 91 471) 2432647
E-mail: srnair@lifecarehll.com, rajeevrv@lifecarehll.com

7) LIQUIDATED DAMAGES FOR DELAYS

If the material is not supplied to the purchaser within the time stipulated in the Order, Purchaser may at their option, either (1) recover from the Supplier liquidated damages at the rate of 0.5 % of the total purchase order value for every week of delay, subject to a maximum of 7.5 % of the total purchase order value, or (2) at the risk and cost of the Supplier and without prejudice to the other remedies/rights as per the Contract, terminate the order wholly or partially and complete it themselves or reassign it to other Suppliers.

8) PAYMENT TERMS

95% of the total supply price will be paid against supply, inspection and acceptance of the items at HLL, KANAGALA site, within 30 days and balance 5% will be released against performance bank guarantee valid for guarantee period as per tender.

9) SETTLEMENT OF DISPUTES

Any disputes or differences or questions or claims arising under or relating to or touching this agreement shall be referred for arbitration to a Sole Arbitrator under the provisions of the Arbitration and Conciliation Act 1996 or any statutory modification or re-enactment thereof for the time be in force. The award passed by the arbitrator shall be final and binding on the parties hereto.

The contract shall be deemed to have been concluded at Thiruvananthapuram, Kerala and suits and proceedings, if any, shall be only in the courts of competent jurisdiction in Thiruvananthapuram.

The venue of arbitration shall be the place from where the contract is issued.

The company reserves the right to club or split the items of supply and reject or cancel the Invitation for bids without assigning any reason thereof.

SCHEDULE III
ACCEPTANCE FORM

(To be submitted in the letter pad of the firm indicating full name and address, telephone & fax numbers etc.)

From

To

Associate Vice President (CED)
Central Engineering Division,
HLL Lifecare Limited (A Government of India Enterprise),
PB No 2, Peroorkada, Thiruvananthapuram – 695005,
Kerala State, India
Ph: (++91 471) 2433374,2437270 –501,502
Tele Fax: (++ 91 471) 2432647
E-mail: snair@lifecarehll.com, rajeevrv@lifecarehll.com

Dear Sir,

I / We, hereby offer to supply materials as detailed in schedule here to or such portion thereof as you may specify in the acceptance of Bid at the price given in the price bid and agree to hold this offer open till 90 days after the date of bid opening prescribed by the purchaser. I/We have understood the terms and conditions mentioned in the invitation for bid and Conditions of Contract furnished by you and have thoroughly examined the specifications and drawings in the bid document hereto and are fully aware of the nature of the scope of supply and my/our offer is to comply strictly in accordance with the requirement and the terms and conditions mentioned above. I/We have understood that the PURCHASER is the sole owner of the technology, equipment, specification and drawings given along with the bidding documents. I/we here by assure that the above information will be kept confidential and will not be used for any other purpose or will not be transferred to third party.

Yours faithfully,

SIGNATURE OF THE BIDDER

**SCHEDULE IV
SCHEDULE OF ITEMS**

**SCHEDULE FOR THE SUPPLY OF BRUSHES FOR CONDOM DIPPING MACHINES AT
OUR FACTORY IN KANAGALA, BELGAUM**

Sl.No.	Description of Item	Unit	Quantity	Rate in Rs.	Amount in Rs.
1.	Supply of brushes with shaft as per drawing no.HLL-CED-B2-005-05	Set	16		
2.	Supply of brushes with shaft as per drawing no.HLL-CED-B2-005-04	Nos.	10		
3.	Supply of brushes with shaft as per drawing no.HLL-CED-B2-005-06	Nos.	4		
4	Supply of brushes with shaft as per drawing no.HLL-CED-B2-005-07	Nos.	14		
5	Supply of brushes with shaft as per drawing no.HLL-CED-B2-019-00	Nos.	4		
	Basic price in Rs.				
	CST in Rs.				
	Freight charges in Rs.				
	Packing & Forwarding charges Rs.				
	Other taxes/Charges any in Rs.				
	Gross Amount in Rs.				

(In words)

I agree to supply all the items as per schedule at the rates quoted by me as above and the terms and conditions of the tender document.

SIGNATURE OF THE SUPPLIER

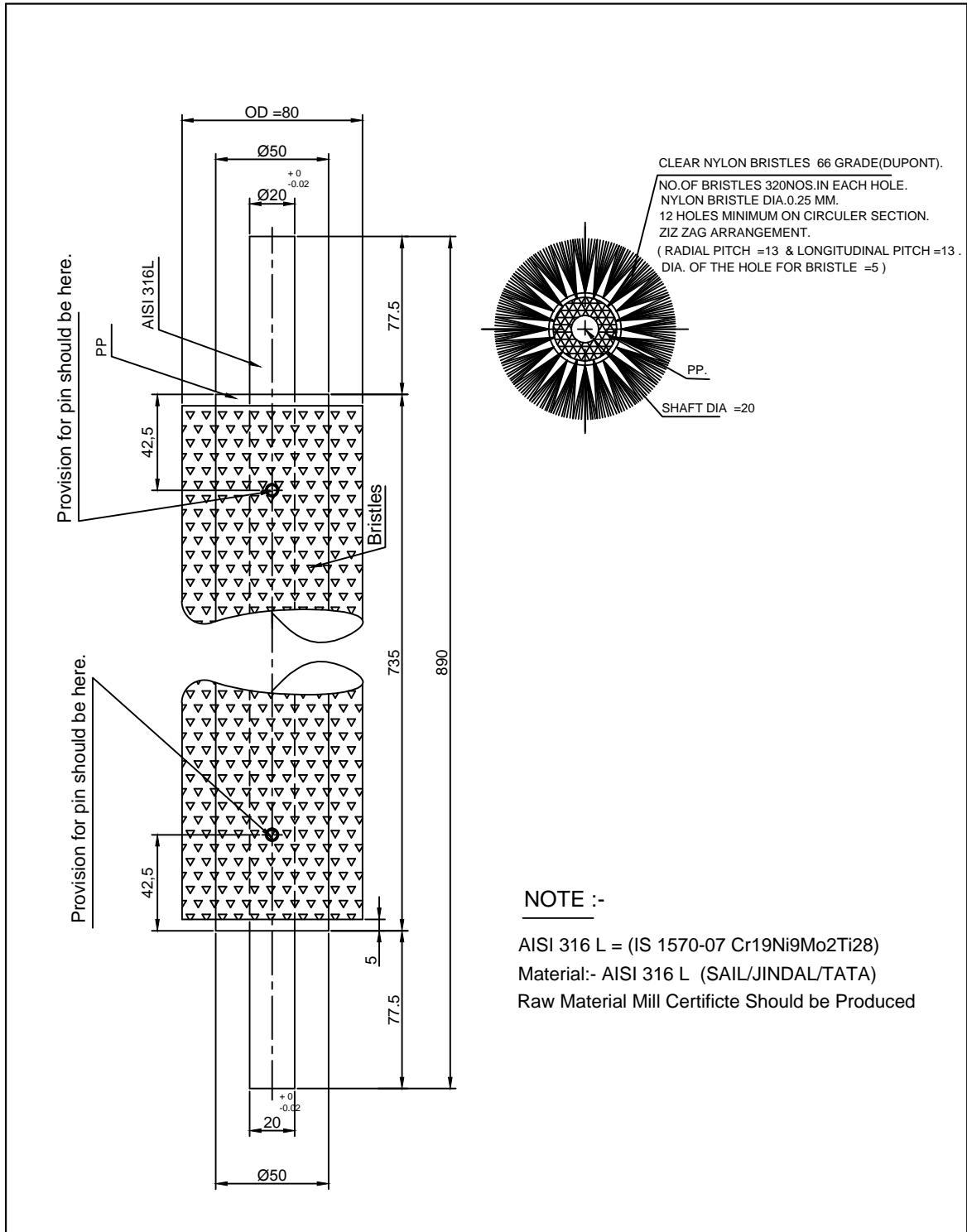

NOTE :-

AISI 316 L = (IS 1570-07 Cr19Ni9Mo2Ti28)
 Material:- AISI 316 L (SAIL/JINDAL/TATA)
 Raw Material Mill Certificate Should be Produced

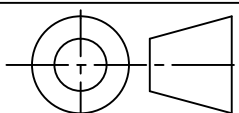
MATERIAL:- PP, NYLON & AISI316L		HLL LIFECARE LIMITED. Thiruvananthapuram-5		NO.OFF.				
DRAWN BY:	PAUL M.P	TITLE:- BEADING BRUSH & SHAFT (BTADL CDM)						
CHECKED BY:								
APPROVED BY:		 Drg.no:- HLL-CED -B2-019-00						
DATE:	11-07-2013							
SCALE:		SHEET NO. 1 OFF. 1 <table border="1" style="float: right;"> <tr> <td>REV:-</td> <td></td> </tr> <tr> <td>Date:-</td> <td></td> </tr> </table>			REV:-		Date:-	
REV:-								
Date:-								
ALL DIMENSIONS ARE IN M.M.								

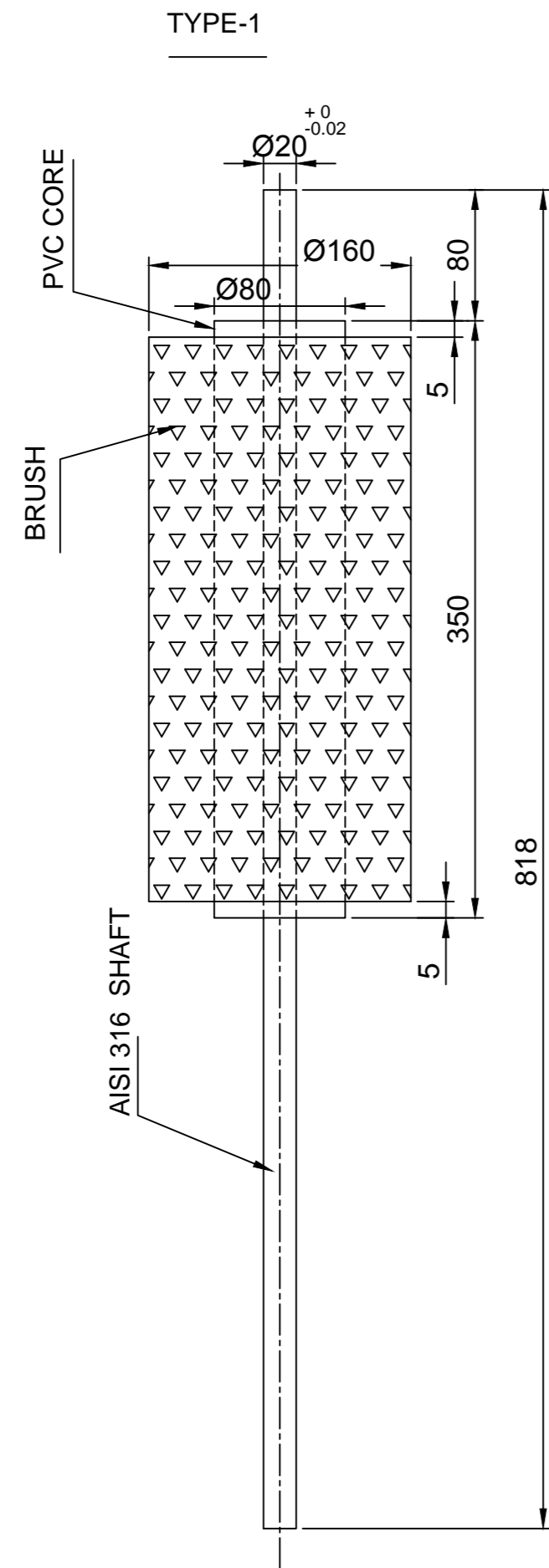

SHAFT -Ø20 x818 Length
BRUSH -Ø160x350 Length

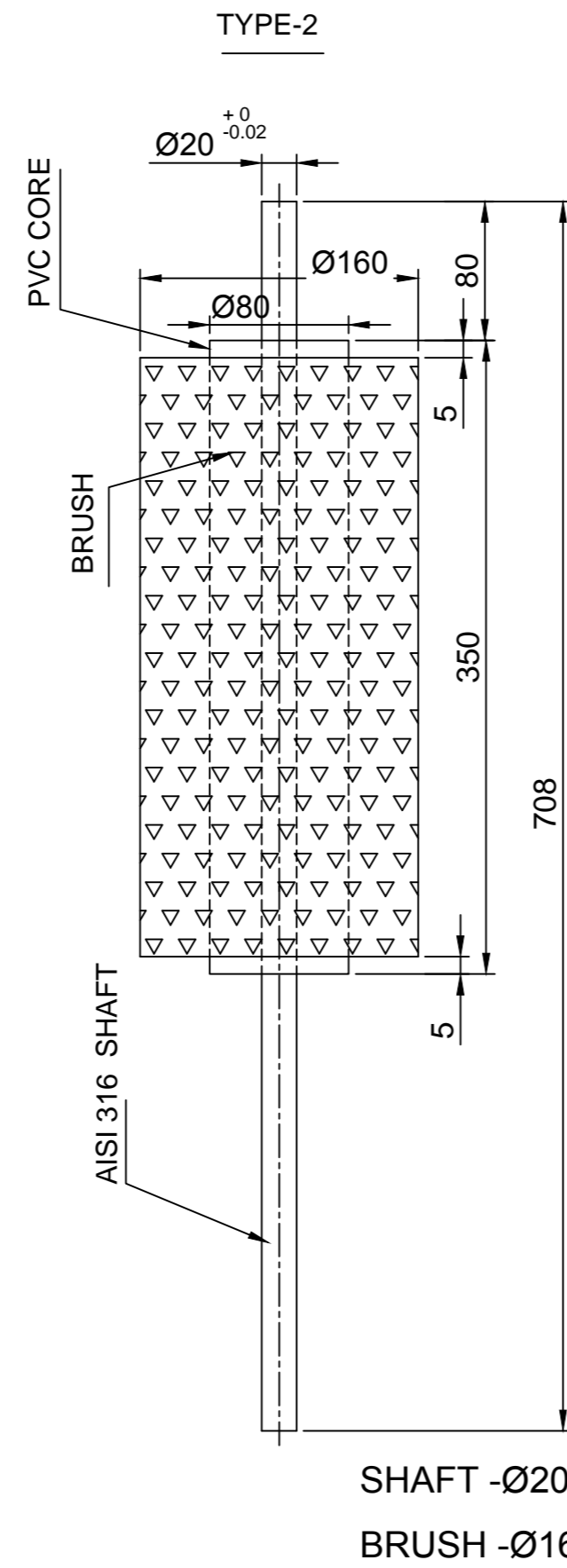

SHAFT -Ø20 x708 Length
BRUSH -Ø160x350 Length

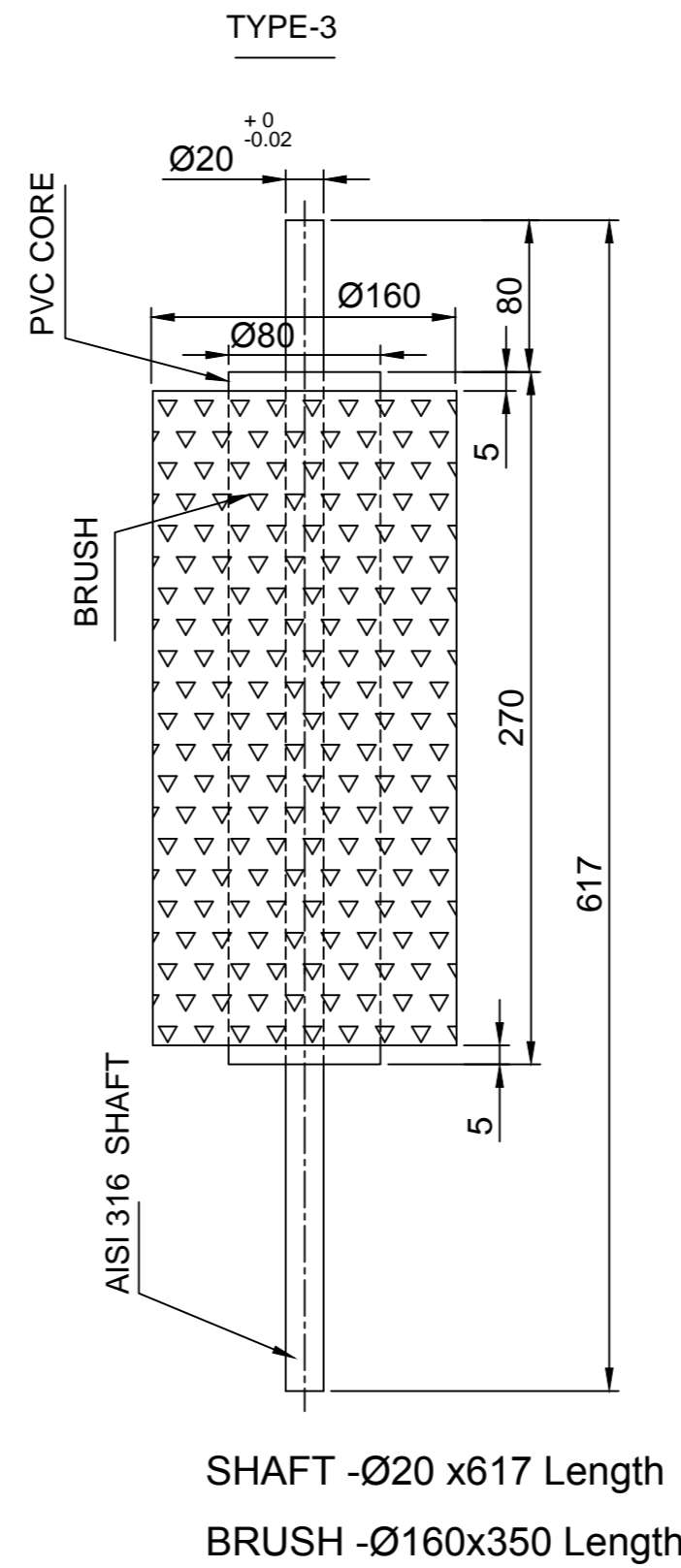

SHAFT -Ø20 x617 Length
BRUSH -Ø160x350 Length

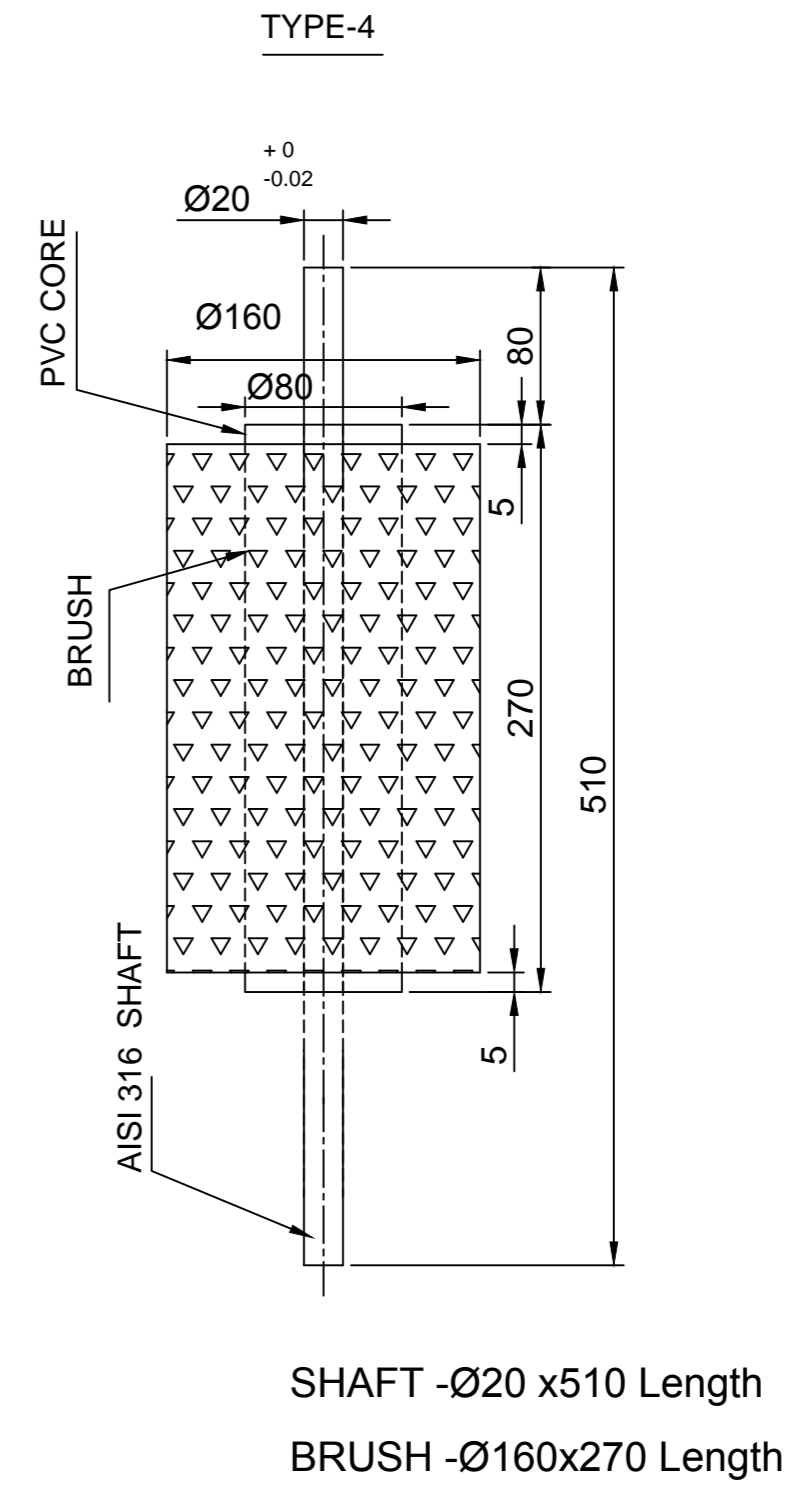

SHAFT -Ø20 x510 Length
BRUSH -Ø160x270 Length

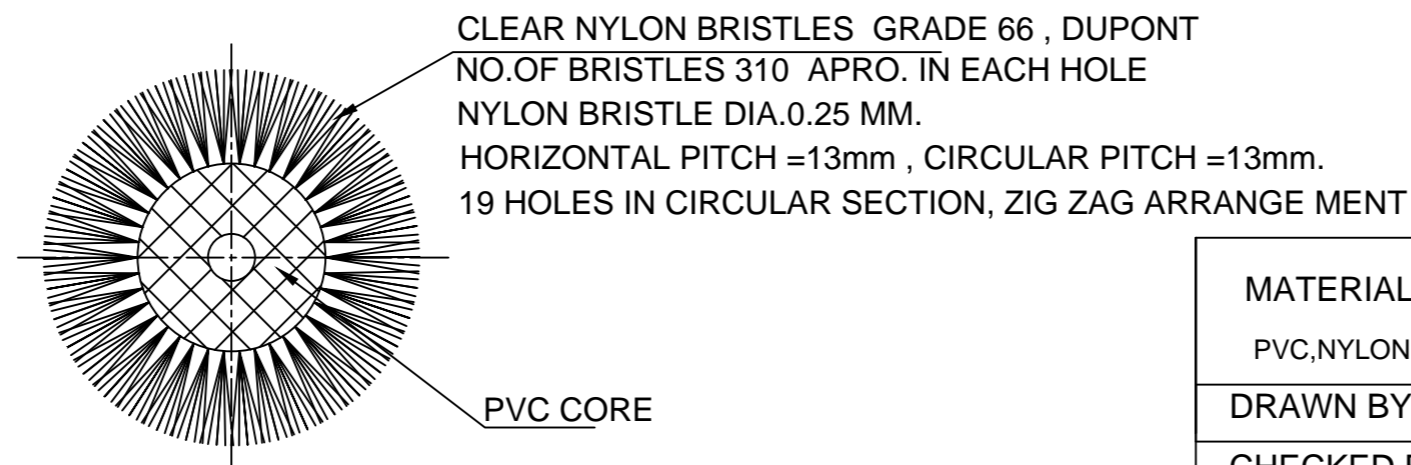

CLEAR NYLON BRISTLES GRADE 66 , DUPONT
NO.OF BRISTLES 310 APRO. IN EACH HOLE
NYLON BRISTLE DIA.0.25 MM.
HORIZONTAL PITCH =13mm , CIRCULAR PITCH =13mm.
19 HOLES IN CIRCULAR SECTION, ZIG ZAG ARRANGE MENT

NOTE :-

ALL SHAFTS WITH M5 THREADED BORING,TO FIX THE BRUSHES.

AISI 316 L = (IS 1570-07 Cr19Ni9Mo2Ti28)

Material:- AISI 316 L (SAIL/JINDAL/TATA)

Raw Material Mill Certificate Should be Produced

MATERIAL: PVC,NYLON & AISI 316.	HLL Lifcare Limited. Thiruvananthapuram-5		NO:OFF.
DRAWN BY: PAUL M.P	TITLE:- INCLINED BRUSH & SHAFT (BTADL CDM)		
CHECKED BY:			
APPROVED BY:			
DATE: 14-06-2013	Drg.no:-HLL-CED-B2-005-05		
SCALE:	SHEET.NO:-1OFF.1		REV:- DATE:-
ALL DIMENSIONS ARE IN M.M			

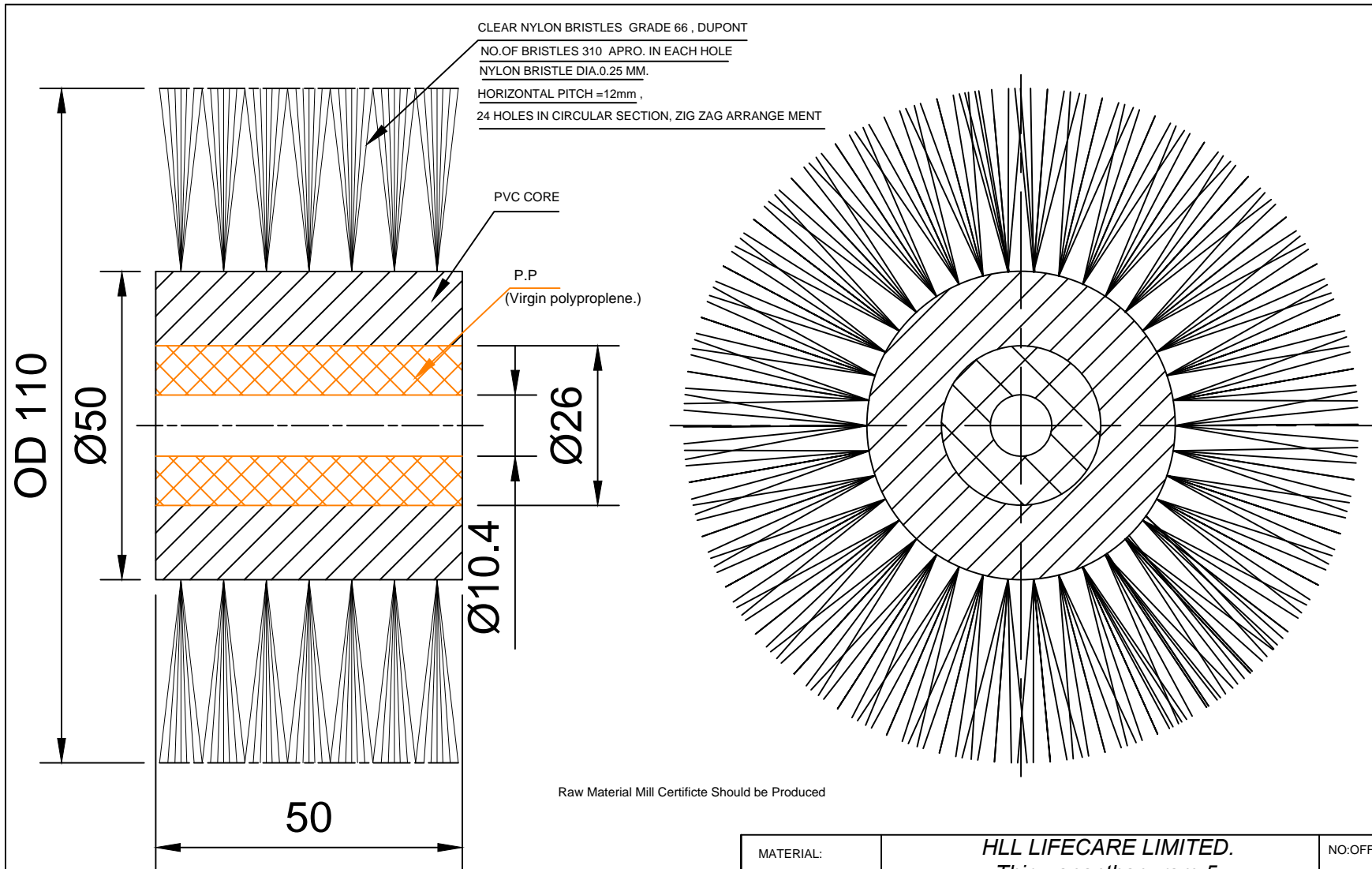

Raw Material Mill Certificate Should be Produced

MATERIAL: PVC,NYLON &PP	HLL LIFECARE LIMITED. Thiruvananthapuram-5		NO:OFF.
DRAWN BY:	PAUL.M.P	TITLE:-	NIPPLE CLEANING BRUSH(SMALL)
CHECKED BY:			
APPROVED BY:			
DATE:	14-06-2013		
SCALE:			
ALL DIMENSIONS ARE IN M.M			Drg.no:-HLL-CED-B2-005-07
		SHEET.NO:-1OFF.1	REV:- DATE:-

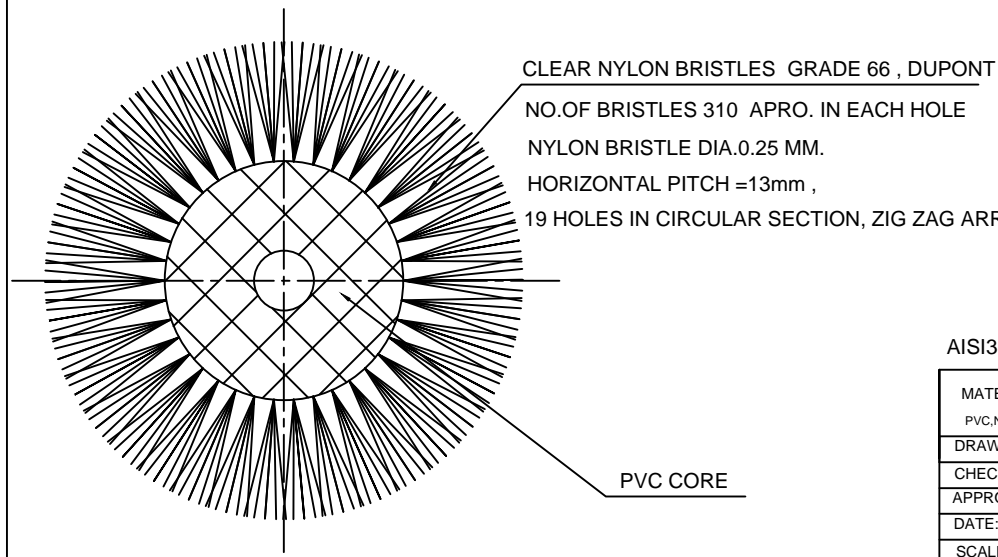
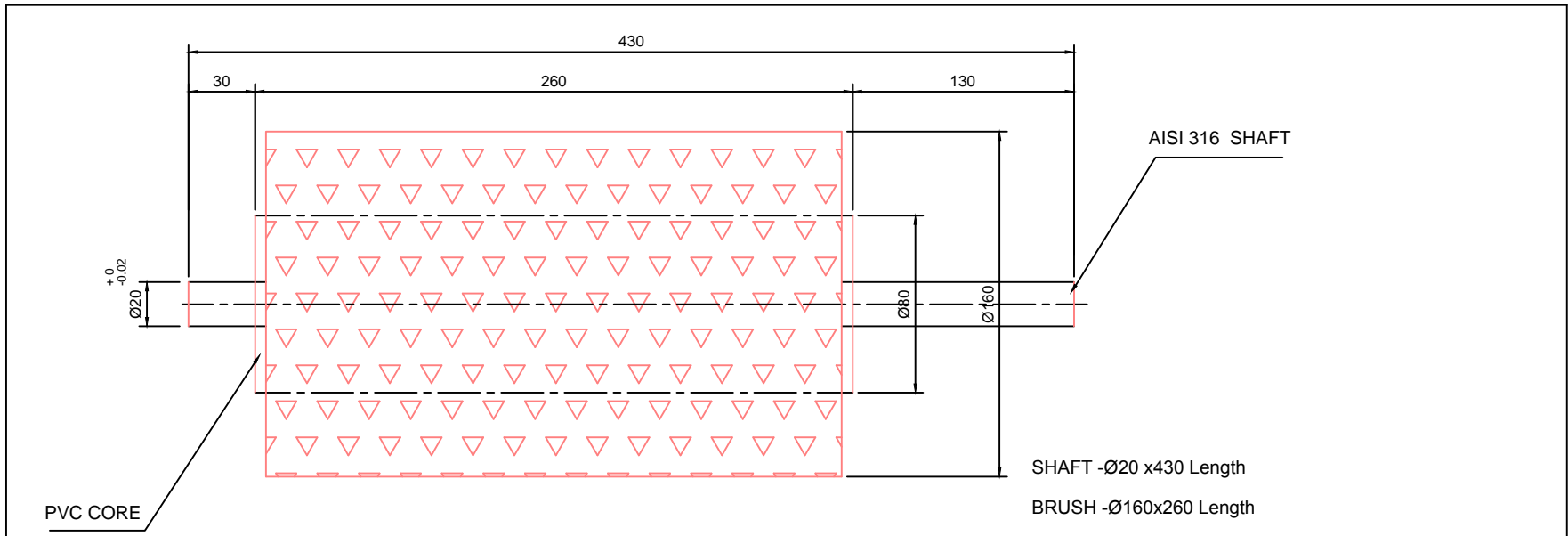

NOTE :-

SHAFTS WITH M5 THREADED BORING,TO FIX THE BRUSHES.

AISI 316 L = (IS 1570-07 Cr19Ni9Mo2Ti28)

Material:- AISI 316 L (SAIL/JINDAL/TATA)

Raw Material Mill Certificate Should be Produced

AISI316 = (IS 1570-07 Cr19Ni9Mo2Ti28)

MATERIAL: PVC,NYLON & AISI 316.	HLL LIFECARE LIMITED. Thiruvananthapuram-5		NO:OFF.
DRAWN BY: PAUL.M.P	TITLE:- NIPPLE CLEANING BRUSH& SHAFT(BTADL CDM)		
CHECKED BY:	Drg.no:-HLL-CED-B2-005-06		
APPROVED BY:	SHEET.NO:-1OFF.1		
DATE: 08-08-2013	REV:-		
SCALE:	DATE:-		
ALL DIMENSIONS ARE IN M.M			

CLEAR NYLON BRISTLES GRADE 66 DUPONT
 NYLON BRISTLE DIA.0.25 MM.
 NO.OF BRISTLES 310 APRO. IN EACH HOLE
 HORIZONTAL PITCH =13mm , CIRCULAR PITCH =13 mm.
 31 HOLES IN CIRCULAR SECTION,
 ZIG ZAG ARRANGE MENT

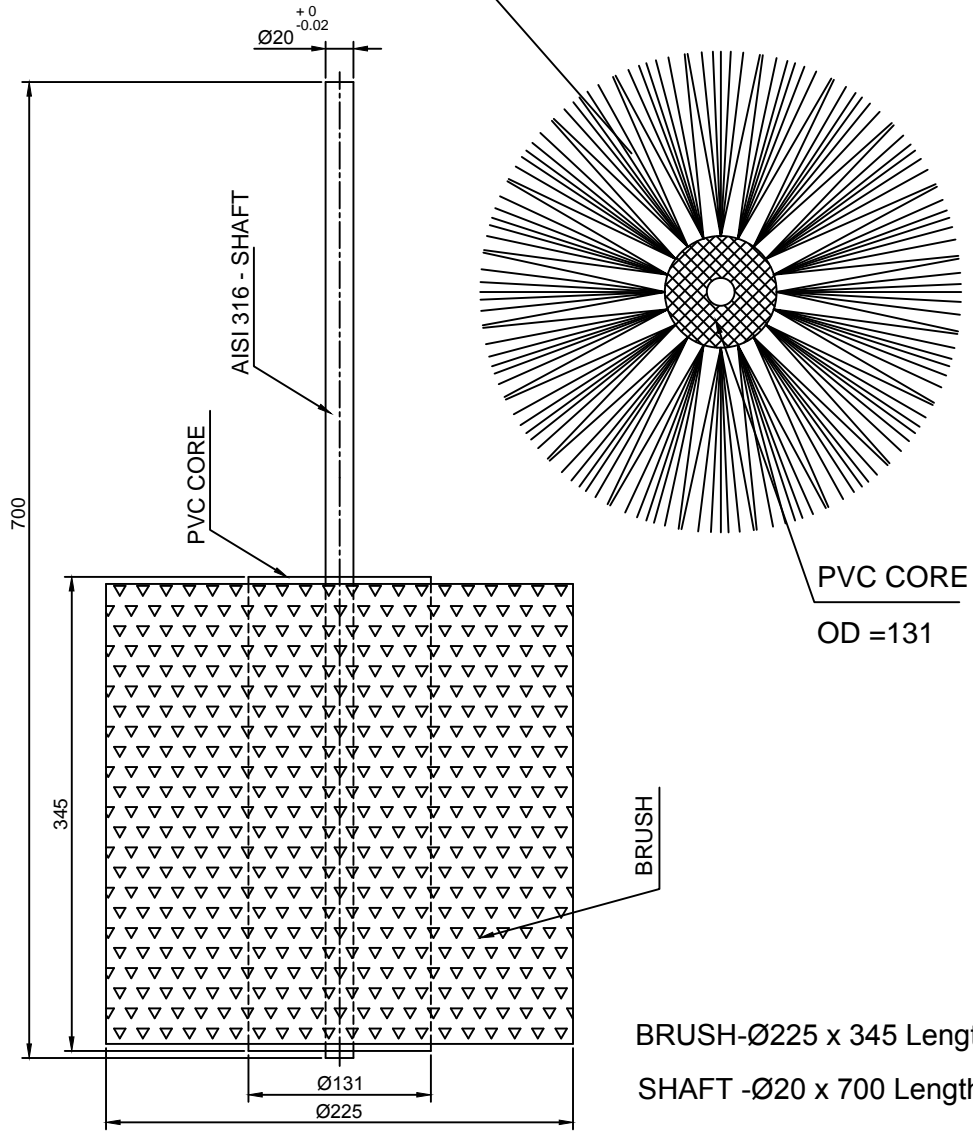

BRUSH-Ø225 x 345 Length
 SHAFT -Ø20 x 700 Length

NOTE :-

Raw Material Mill Certificate Should be Produced

AISI 316 = IS 1570-07 Cr19Ni9Mo2Ti28)

SHAFT WITH M5 THREADED BORING,TO FIX THE BRUSHES.

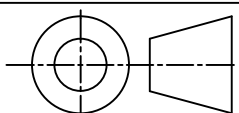
MATERIAL:- PVC,NYLON & AISI 316		HLL Lifecare Limited.		NO.OFF.
DRAWN BY: PAUL M.P.		TITLE:- VERTICAL BRUSH & SHAFT (BTADL CDM)		
CHECKED BY:				
APPROVED BY:				
DATE: 14-06-2013		Drg .no:- HLL-CED-B2-005-04		
SCALE:		SHEET NO. 1 OFF. 1		REV:- 0
ALL DIMENSIONS ARE IN M.M.		DATE:-		